



REPUBLIC OF THE PHILIPPINES
DEPARTMENT OF FINANCE
BUREAU OF CUSTOMS
MANILA 1099

MASTER COPY
AK

May 28, 2015

CUSTOMS MEMORANDUM CIRCULAR
NO. 62-2015

TO: All Deputy Commissioners
All Directors and Division Chiefs
All District / Port Collectors
and Others Concerned

SUBJECT: Tariff Commission Rulings covering TCC Nos. 14-441, 14-445, 15-109, 15-113, 15-114, 15-116 and 15-117)

Attached is the letter dated 26 May 2015 of Mr. Edgardo B. Abon, Chairman, Tariff Commission, furnishing this Bureau with copies of their rulings with TCC Nos. 14-441, 14-445, 15-109, 15-113, 15-114, 15-116 and 15-117, together with their respective brochures/technical literature issued from 13 May 2015 to 26 May 2015.

For your information and guidance.

Please confirm the dissemination of this circular throughout your offices within fifteen (15) days from receipt hereof.

Alberto D. Lina
ALBERTO D. LINA
& Commissioner
Bureau of Customs
ALBERTO D. LINA
Commissioner
15-00364

JUL 01 2015

Ranve 6/2/2015



MASTER COPY

REPUBLIC OF THE PHILIPPINES
TARIFF COMMISSION

26 May 2015

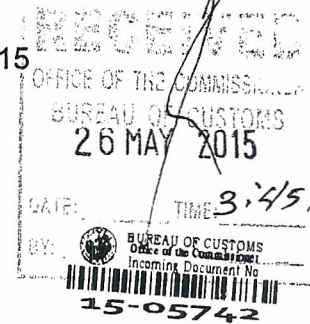

Honorable Alberto D. Lina
Commissioner
Bureau of Customs
Port Area, Manila

Sir:

Pursuant to the provisions of Section 505(i) of the Tariff and Customs Code, as amended, I am pleased to furnish your Office copies of this Commission's rulings with TCC No. 14-441, 14-445, 15-109, 15-113, 15-114, 15-116 and 15-117 together with their respective brochures/technical literature issued by this Commission from 13 May 2015 to 26 May 2015.

Very truly yours,

EDGARDO B. ABON
Chairman

Encl.: As stated.

cc: The Honorable Secretary
Department of Finance
Manila





REPUBLIC OF THE PHILIPPINES

TARIFF COMMISSION

1	CLASSIFICATION
	AHTN 8536.90.94 MFN - 1% ad valorem ACFTA - 1% ad valorem

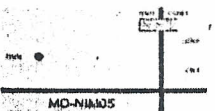
2	TCC NO.
	14-441

3	DATE 15 May 2015
4	<p>DESCRIPTION</p> <p>“MD-NIM05/E-1 HOTEL CARD KEY INTERFACE MODULE”</p> <p>Based on the brochure and technical specifications submitted, subject article is a card-key interface module with electricity voltage of 5 V and current of less than 16 A. It connects the hotel card-insert system to the indoor unit display board of air conditioner and cooperates with the wired controller to automate the air conditioner’s control.</p>  <p>During operation, when the card key is inserted into the card holder, the module will work and provide the power supply to the fan coil unit (FCU). When the card key is taken out, FCU’s power supply will be cut off and the module records the running status and recovers the unit to previous running status when powered on.</p>
5	<p>HEADING 85.36</p> <p>SUBHEADING AHTN 8536.90.94</p> <p>CONSIDERED</p>
6	<p>REASONS FOR CLASSIFICATION</p> <p>Heading 85.36 of the ASEAN Harmonized Tariff Nomenclature (AHTN) Tariff and Customs Code covers, among others, electrical apparatus for switching or protecting electrical circuits, or for making connections to or in electrical circuits (for example, switches, relays and other connectors,), for a voltage not exceeding 1,000 volts. The pertinent Harmonized System (HS) Explanatory Notes (ENs) state that this heading covers electrical apparatus for a voltage not exceeding 1,000 volts generally used for dwellings or industrial equipment. The heading includes, among others, apparatus for making connections to or in electrical circuits. This apparatus is used to connect together the various parts of an electrical circuit.</p> <p>In view thereof, subject article is classified under 2012 AHTN subheading 8536.90.94 of the Code, with Most Favoured Nation (MFN) rate of duty of 1% ad valorem. Under the ASEAN-China Free Trade Area (ACFTA), said product is in the Sensitive List of the Philippines with an ACFTA rate of duty of 1% ad valorem effective 25 April 2012 with the issuance of Executive Order (EO) No. 72.</p> <p style="text-align: right;">FOR THE COMMISSION</p> <p style="text-align: right;"> EDGARDO B. ABON Chairman</p> <p>Date Issued: 26 May 2015</p>



MASTER COPY

REPUBLIC OF THE PHILIPPINES

TARIFF COMMISSION

1	CLASSIFICATION	2	TCC NO.
	AHTN 8536.20.11 MFN – 5% ad valorem ACFTA – Zero		14-445

3 DATE 12 May 2015

4 DESCRIPTION

**“THREE-PHASE PROTECTORS,
Models: DPA51CM44-T, DPA53CM23-T, DPB71CM48-T and HWUA”**

Based on the technical information submitted, subject articles are three-phase, moulded case, automatic circuit breakers designed to protect the compressor of Midea® air-cooled condensing units. They detect abnormal power conditions and automatically cut off the power supply when the upper or lower limit is exceeded. Once the power condition is back to normal, subject articles automatically recover the power supply for the unit. With current rating below 16 A, their specifications are:

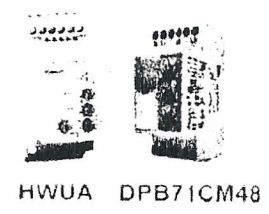

Model	With over/under voltage function				Without over/ under voltage function
	HWUA	DPA53CM23-T	HWUA	DPB71CM48-T	DPA51CM44-T
Power supply	220-480V, 50/60 Hz	208-480V, 50/60 Hz	220-480V, 50/60 Hz	380-480V, 50/60 Hz	208-480V, 50/60 Hz
Rated operation power	2.9 VA	7 VA	2.9 VA	13 VA	13 VA
Over voltage	12%	12%	18%	18%	-
Under voltage	-12%	-12%	-12%	-12%	-
Dimensions (WxHxD) (mm)	90 x 69 x 35	81 x 67.2 x 17.5	90 x 69 x 35	81 x 67 x 35	81 x 67.2 x 17.5

**5 HEADING 85.36
SUBHEADING AHTN 8536.20.11
CONSIDERED**

6 REASONS FOR CLASSIFICATION

Heading 85.36 of the ASEAN Harmonized Tariff Nomenclature (AHTN) Tariff and Customs Code covers, among others, electrical apparatus for switching or protecting electrical circuits, or for making connections to or in electrical circuits (for example, switches, relays, fuses, surge suppressors, plugs, sockets, lamp-holders and other connectors, junction boxes), for a voltage not exceeding 1,000 volts. The pertinent Harmonized System (HS) Explanatory Notes (ENs) state that the heading includes other devices for preventing overload of circuits (e.g., electro-magnetic devices which automatically break the circuit when the current exceeds a certain value).

In view thereof, subject articles are classified under 2012 AHTN subheading 8536.20.11 of the Code with a Most Favoured Nation (MFN) rate of duty of 5% ad valorem and ASEAN-China Free Trade Area (ACFTA) rate of duty of zero, subject to submission of Certificate of Origin (CO) Form E.

FOR THE COMMISSION

EDGARDO B. ABON
Chairman

Date issued: 13 May 2015



MASTER COPY *AB*

REPUBLIC OF THE PHILIPPINES

TARIFF COMMISSION

1	CLASSIFICATION
	AHTN 1901.20.10 MFN - 10% ad valorem

2	TCC NO.
	15-109

3	DATE 13 May 2015						
4	<p>DESCRIPTION</p> <p style="text-align: center;">“PREMIX TEGRAL SATIN CREAM CAKE”</p> <p>Based on the technical data sheet submitted, subject article is a white to off-white patisserie premix powder composed of wheat flour, sodium bicarbonate (E500ii), as raising agent, sodium stearoyl-2-lactylate (E481), as emulsifier, and guar gum (E412) and sodium carboxy methyl cellulose (E466), as stabilizers. Packed in 25 kg bags, it is used for the preparation of American style crème cakes.</p>						
5	<table> <tr> <td>HEADING</td> <td>19.01</td> </tr> <tr> <td>SUBHEADING</td> <td>AHTN 1901.20.10</td> </tr> <tr> <td>CONSIDERED</td> <td></td> </tr> </table>	HEADING	19.01	SUBHEADING	AHTN 1901.20.10	CONSIDERED	
HEADING	19.01						
SUBHEADING	AHTN 1901.20.10						
CONSIDERED							
6	<p>REASONS FOR CLASSIFICATION</p> <p>Heading 19.01 of the ASEAN Harmonized Tariff Nomenclature (AHTN) Tariff and Customs Code covers, among others, food preparations of flour, groats, meal, starch or malt extract, not containing cocoa or containing less than 40 % by weight of cocoa calculated on a totally defatted basis, not elsewhere specified or included. The pertinent Harmonized System (HS) Explanatory Notes (ENs) state that this heading covers a number of food preparations with a basis of flour, groats or meal, of starch or of malt extract, which derive their essential character from such materials whether or not these ingredients predominate by weight or volume. Other substances may be added to these main ingredients, such as milk, sugar, eggs, casein, albumin, fat, oil, flavouring, gluten, colouring, vitamins, fruit or other substances to improve their dietetic value, or cocoa, in the latter case, in any proportion less than 40 % by weight of cocoa calculated on a totally defatted basis</p> <p>In view thereof, subject article is classified under 2012 AHTN subheading 1901.20.10 of the Code, with a Most Favoured Nation (MFN) rate of duty of 10% ad valorem.</p> <p style="text-align: right;">FOR THE COMMISSION</p> <p style="text-align: right;"><i>Edgardo B. Abon</i> EDGARDO B. ABON Chairman</p> <p>Date Issued: 15 May 2015</p>						



MASTER COPY

REPUBLIC OF THE PHILIPPINES

TARIFF COMMISSION

1	CLASSIFICATION
	AHTN 8471.90.20 MFN - Zero

2	TCC NO.
	15-113

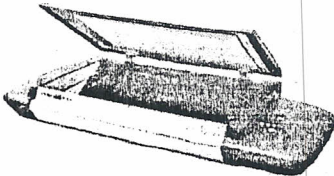
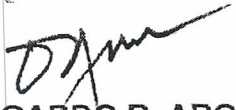
3	DATE 13 May 2015									
4	<p>DESCRIPTION</p> <p style="text-align: center;">“CONTEX HD iFLEX”</p> <p>Based on the brochure and technical specifications submitted, subject article is a document and material scanner with detachable lid. It is to be connected to the computer to operate and scan multiple items and saved into single or multipage files. The scanned files are saved in the computer or in external storage devices in formats such as TIF, JPG, PDF, PDF/A, DWF, etc.</p> <div style="text-align: center;">  </div> <p>Rated at 100 ~ 240 V, 50/60 Hz, 80 W, subject article weighs 34 kg and measures 128x63x22 cm (LxWxH) with scan area of 610x457 mm (LxW) and maximum scan resolution of 9,600 dpi.</p>									
5	<table border="0"> <tr> <td>HEADING</td> <td></td> <td>84.71</td> </tr> <tr> <td>SUBHEADING</td> <td>AHTN</td> <td>8471.90.20</td> </tr> <tr> <td>CONSIDERED</td> <td></td> <td></td> </tr> </table>	HEADING		84.71	SUBHEADING	AHTN	8471.90.20	CONSIDERED		
HEADING		84.71								
SUBHEADING	AHTN	8471.90.20								
CONSIDERED										
6	<p>REASONS FOR CLASSIFICATION</p> <p>Heading 84.71 of the ASEAN Harmonized Tariff Nomenclature (AHTN) Tariff and Customs Code covers, among others, magnetic or optical readers, machines for transcribing data onto data media in coded form and machines for processing such data, not elsewhere specified or included. The pertinent Harmonized System (HS) Explanatory Notes (ENs) to subheading 8471.90 state that this subheading covers, inter alia, optical disc filing systems which usually include keyboards, displays, optical disc drive units, scanners and printers. These systems may include an automatic data processing machine as the controller or they may be configured such that they are accessible or controllable by an automatic data processing machine. These systems generally perform, among others, recording the image by electronic scanning.</p> <p>In view thereof, subject article is classified under 2012 AHTN subheading 8471.90.20 of the Code, with a Most Favoured Nation (MFN) rate of duty of zero.</p> <p style="text-align: right;">FOR THE COMMISSION</p> <div style="text-align: right;">  EDGARDO B. ABON Chairman </div> <p>Date Issued: 15 May 2015</p>									

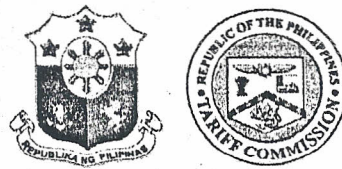

REPUBLIC OF THE PHILIPPINES

TARIFF COMMISSION

1	CLASSIFICATION	2	TCC NO.
	AHTN 8471.90.20 MFN - Zero		15-114

3 DATE 13 May 2015

4 DESCRIPTION

"CONTEX SD ONE 24"

Based on the brochure and technical specifications submitted, subject article is a desktop large format document scanner with a maximum scan width of 24 inches. This device is to be connected to the computer to operate and function as a sheet-feed scanner with an automatic document feeder. The scanned files are saved in the computer or in external storage devices in formats such as TIF, JPG, PDF and PDF/A, or integrated in cloud storage websites. Rated at 100 ~ 240 V, 50/60 Hz, 16 W, subject article weighs 8.5 kg and measures 819x230x124 mm (LxWxH).

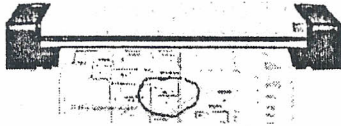

5 HEADING 84.71
SUBHEADING AHTN 8471.90.20
CONSIDERED

6 REASONS FOR CLASSIFICATION

Heading 84.71 of the ASEAN Harmonized Tariff Nomenclature (AHTN) Tariff and Customs Code covers, among others, magnetic or optical readers, machines for transcribing data onto data media in coded form and machines for processing such data, not elsewhere specified or included. The pertinent Harmonized System (HS) Explanatory Notes (ENs) to subheading 8471.90 state that this subheading covers, inter alia, optical disc filing systems which usually include keyboards, displays, optical disc drive units, scanners and printers. These systems may include an automatic data processing machine as the controller or they may be configured such that they are accessible or controllable by an automatic data processing machine. These systems generally perform, among others, recording the image by electronic scanning.

In view thereof, subject article is classified under 2012 AHTN subheading 8471.90.20 of the Code, with a Most Favoured Nation (MFN) rate of duty of zero.

FOR THE COMMISSION

EDGARDO B. ABON
Chairman

Date Issued: 15 May 2015



REPUBLIC OF THE PHILIPPINES

TARIFF COMMISSION

1	CLASSIFICATION
	AHTN 9617.00.10 MFN - 3% ad valorem ACFTA - Zero

2	TCC NO.
	15-116

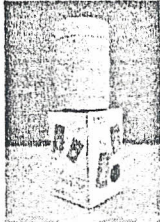
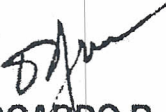
3	DATE 18 May 2015									
4	<p style="text-align: center;">DESCRIPTION</p> <p style="text-align: center;">“TUPPERWARE® MINI THERMOS”</p> <p>Based on the technical data sheet and sample submitted, subject article is a 250 mL double-walled vacuum thermal flask that keeps beverages hot or cold up to six (6) hours. The inner and outer part of the flask is made of stainless steel and the lid is made of polypropylene (PP) with a silicone rubber seal.</p> <div style="text-align: right;">  </div>									
5	<table style="width: 100%; border-collapse: collapse;"> <tr> <td style="width: 30%;">HEADING</td> <td style="width: 30%;"></td> <td style="width: 40%; text-align: center;">96.17</td> </tr> <tr> <td>SUBHEADING</td> <td style="text-align: center;">AHTN</td> <td style="text-align: center;">9617.00.10</td> </tr> <tr> <td colspan="3">CONSIDERED</td> </tr> </table>	HEADING		96.17	SUBHEADING	AHTN	9617.00.10	CONSIDERED		
HEADING		96.17								
SUBHEADING	AHTN	9617.00.10								
CONSIDERED										
6	<p>REASONS FOR CLASSIFICATION</p> <p>Heading 96.17 of the ASEAN Harmonized Tariff Nomenclature (AHTN) Tariff and Customs Code covers, among others, vacuum flasks and other vacuum vessels, complete with cases. The pertinent Harmonized System (HS) Explanatory Notes (ENs) state that this heading covers, among others, vacuum flasks and other similar vacuum vessels, provided they are complete with the cases. This group includes vacuum jars, jugs, carafes, etc., designed to keep liquids, food or other products at fairly constant temperature, for reasonable periods of time. These articles consist of a double-walled receptacle (the inner), generally of glass, with a vacuum created between the walls, and a protective outer casing of metal, plastics or other material, sometimes covered with paper, leather, leather cloth, etc. The space between the vacuum container and the outer casing may be packed with insulating material (glass fibre, cork or felt). In the case of vacuum flasks the lid can often be used as a cup.</p> <p>In view thereof, subject article is classified under 2012 AHTN subheading 9617.00.10 of the Code, with a Most Favoured Nation (MFN) rate of duty of 3% ad valorem and ASEAN-China Free Trade Area (ACFTA) rate of duty of zero, subject to submission of Certificate of Origin (CO) Form E.</p> <div style="text-align: right; margin-top: 20px;"> <p>FOR THE COMMISSION</p>  <p>EDGARDO B. ABON Chairman</p> </div> <p style="margin-top: 20px;">Date Issued: 26 May 2015</p>									





MASTER COPY

REPUBLIC OF THE PHILIPPINES

TARIFF COMMISSION

1	CLASSIFICATION
	AHTN 3924.90.90 MFN - 15% ad valorem ACFTA - Zero

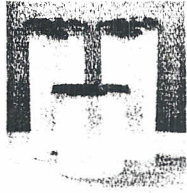
2	TCC NO.
	15-117

3	DATE 15 May 2015									
4	<p style="text-align: center;">DESCRIPTION</p> <p style="text-align: center;">“TUPPERWARE® MODULAR MATE (MM) ROUND #4 (2) and #2 (1) SET”</p> <p>Based on the technical data sheet and samples submitted, subject article is a set of molded plastic containers with lid made of polypropylene clarified random (PP-RC) and linear low density polyethylene (LLDPE). The set is composed of two (2) pieces 1 liter and one (1) piece 440 mL round modular mates used as food storage containers.</p> 									
5	<table style="width: 100%; border: none;"> <tr> <td style="width: 30%;">HEADING</td> <td style="width: 30%;"></td> <td style="width: 40%; text-align: right;">39.24</td> </tr> <tr> <td>SUBHEADING</td> <td style="text-align: center;">AHTN</td> <td style="text-align: right;">3924.90.90</td> </tr> <tr> <td colspan="3">CONSIDERED</td> </tr> </table>	HEADING		39.24	SUBHEADING	AHTN	3924.90.90	CONSIDERED		
HEADING		39.24								
SUBHEADING	AHTN	3924.90.90								
CONSIDERED										
6	<p>REASONS FOR CLASSIFICATION</p> <p>Heading 39.24 of the ASEAN Harmonized Tariff Nomenclature (AHTN) Tariff and Customs Code covers tableware, kitchenware, other household articles and hygienic or toilet articles, of plastics. The pertinent Harmonized System (HS) Explanatory Notes (ENs) state that this heading covers, among others, other household articles such as ash trays, hot water bottles, matchbox holders, dustbins, buckets, watering cans, food storage containers, curtains, drapes, table covers and fitted furniture dust-covers (slipovers).</p> <p>In view thereof, subject article is classified under 2012 AHTN subheading 3924.90.90 of the Code, with a Most Favoured Nation (MFN) rate of duty of 15% ad valorem and ASEAN-China Free Trade Area (ACFTA) rate of duty of zero, subject to submission of Certificate of Origin (CO) Form E.</p> <p style="text-align: right;">FOR THE COMMISSION</p> <p style="text-align: right;"> EDGARDO B. ABON Chairman</p> <p>Date Issued: 18 May 2015</p>									